



Palau de Congressos de Palma

Managed by Meliá Hotels International



Welcome



Palau de Congressos de Palma

Managed by Meliá Hotels International

Welcome to the *Palau de Congressos*, the congress center of Palma de Mallorca. Unique architecture and a marvelous location in the most envied destination of the Mediterranean, provided by the leaders in hotel management, Meliá.



Palma, Mallorca, the Mediterranean

The old town of Palma has constructions that date back to the XIII Century. The baroque and gothic style predominate in the center, which has been listed as the second largest in Europe after Rome. It has a religious heritage of invaluable beauty such as the Palma Cathedral, of gothic style built on roman walls which protected the city, declared artistic monument in 1931. Numerous art galleries occupy the small streets where one should not miss discovering and savoring the excellences of Majorcan gastronomy.



The *Palau* finds itself 15 minutes walking distance from the old town and the Cathedral, and 5 minutes away from the Palma International Airport which has direct connections to the main Spanish and European cities.



Unique architecture

The structure of this building was conceived by **Patxi Mangado**, an internationally renowned architect from Navarra who defines himself as a man in love with the light of Mallorca and the Mediterranean. His latest prize was the 2017 Art Award granted by the Academy of Arts of Berlin which acknowledges his trajectory as an architect and spotlights projects such as the complex formed by the congress center *Palau de Congressos* of Palma and the hotel Meliá Palma Bay, among others.



The *Palau de Congressos* of Palma is built as a continuation of *Baluarte*, a wall that fosters and encloses the charms of a city that is constantly being reborn to the Mediterranean light and the breeze of the sea. This has significantly influenced the choice of materials for the creation of this building.

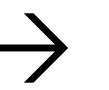

The architect:
Francisco Mangado

Among Francisco Mangado's main works are, the *Centro de Cultura e Iglesia* in Thiene (Italy, 1996), the *Palacio de Congresos y Auditorio* of Pamplona (2003), the *Pey Berland* square in Burdeos (2004), the *Centro Municipal de Exposiciones y Congresos* in Ávila (2009), the *Museo de Arqueología de Vitoria* (2009), the *Campo de Fútbol* of Palencia (2006), the *Pabellón de España* for the *Expo Zaragoza* (2008), the *Auditorio de Teulada* (2011), the *Palacio de Congresos* of Palma de Mallorca (2016), the *Museo de Bellas Artes de Asturias* in Oviedo (2015) and a tower of offices in Buenos Aires (2008). Prize to Spanish Architecture 2017 to the *Palau y Hotel Meliá Palma Bay* complex.

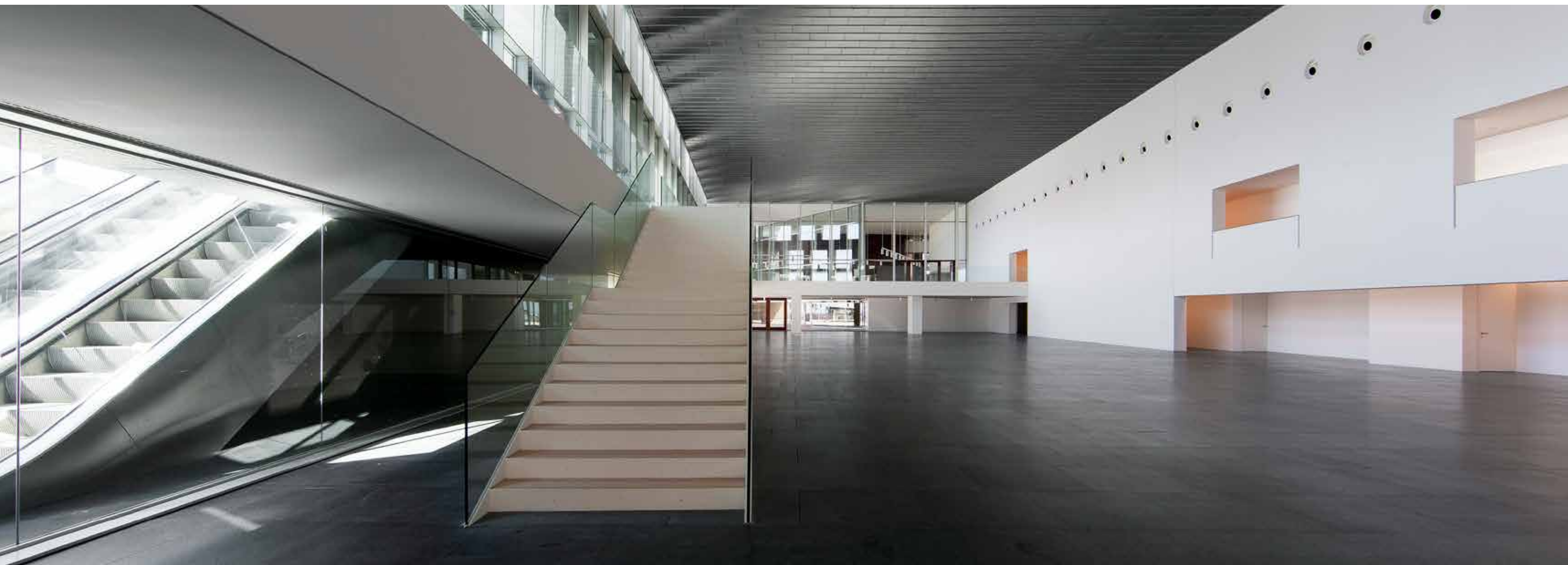

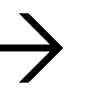

At first view, the *Palau de Congressos* of Palma evokes a hive inside which you can find two magnificent auditoriums with a capacity for 1.966 and 471 people respectively, fully equipped with the latest technology to host all kinds of events, both cultural such as concerts and shows, as well as congresses, meetings, fairs and events. It has a large exhibition area which resembles a cave open towards the sea allowing the Mediterranean light to enter through its large windows, various fully functional meeting rooms of different sizes and an impressive terrace of over 600 m² with incomparable views to the Palma Bay.

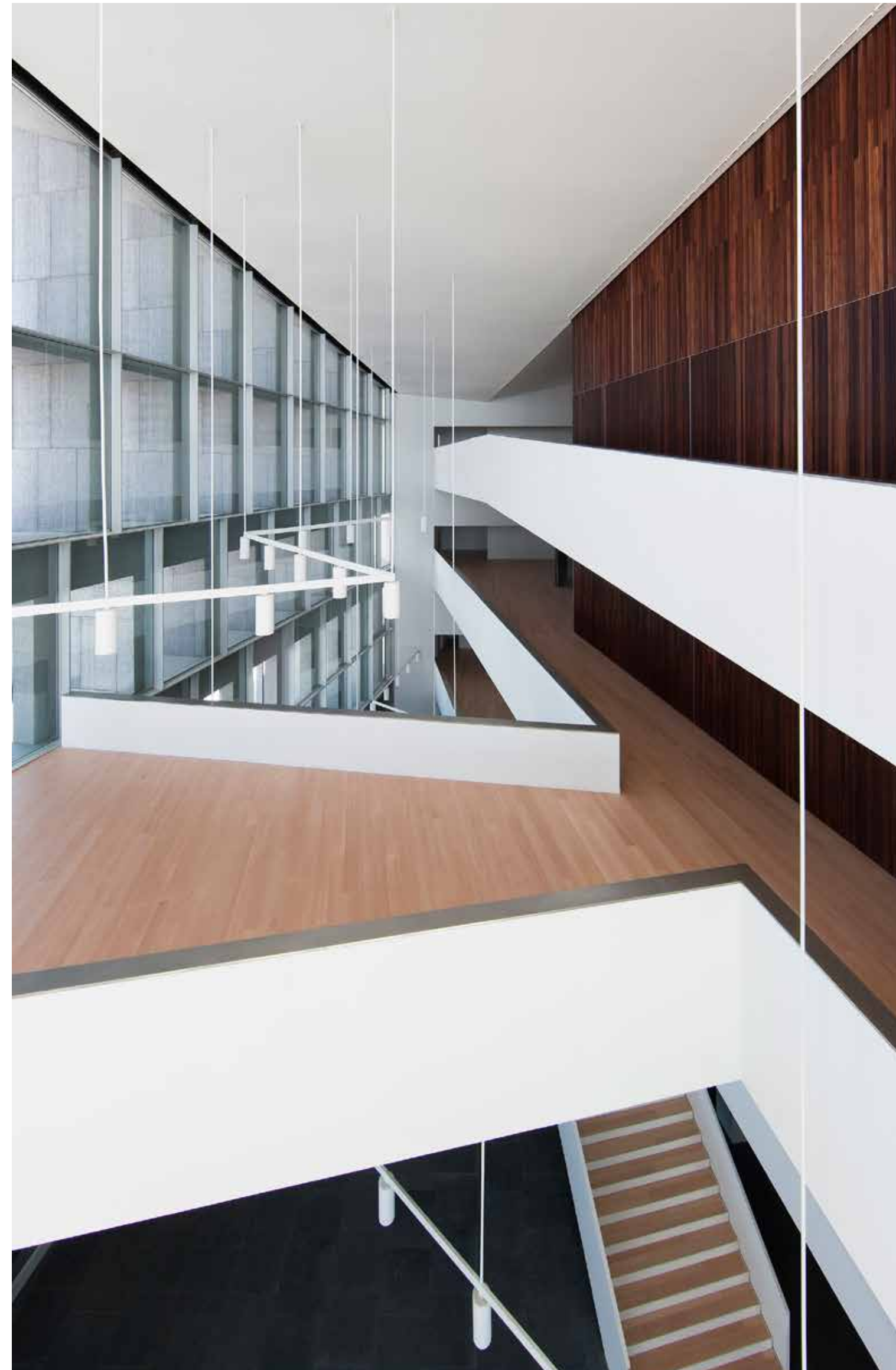

The materials used in the construction of the building are remarkable helping it be a sustainable building.

The architectonic panels ALUSION™ stand out on the Palau's facade. They have been fabricated by means of an injection of air in melted aluminum which contains a fine dispersion of ceramic particles. These particles stabilize the bubbles formed by the air in the same way that dry cocoa stabilizes the bubbles when milk is added.

Both auditoriums offer excellent acoustics designed by the prestigious office HIGINI ARAU, international expert in the field of acoustic architecture.

The wood used was brought from Africa; PADAUK, a tree which can grow to reach up to 40metres high. Its wood is highly appreciated due to its hardness, although it's easy to mold. Initially it is red but turns brown when exposed to the light.

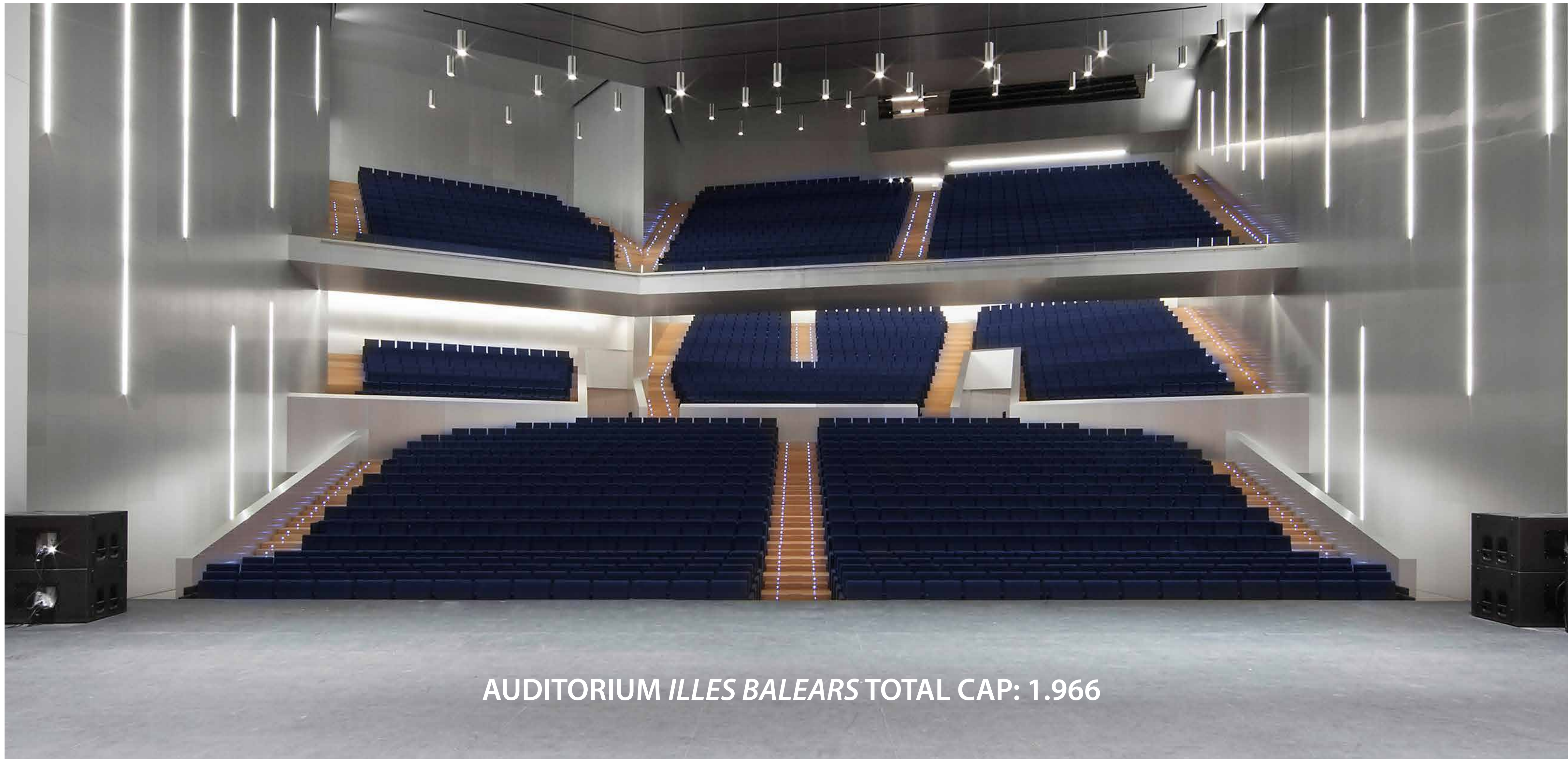

AUDITORIUM ILLES BALEARS TOTAL CAP: 1.966

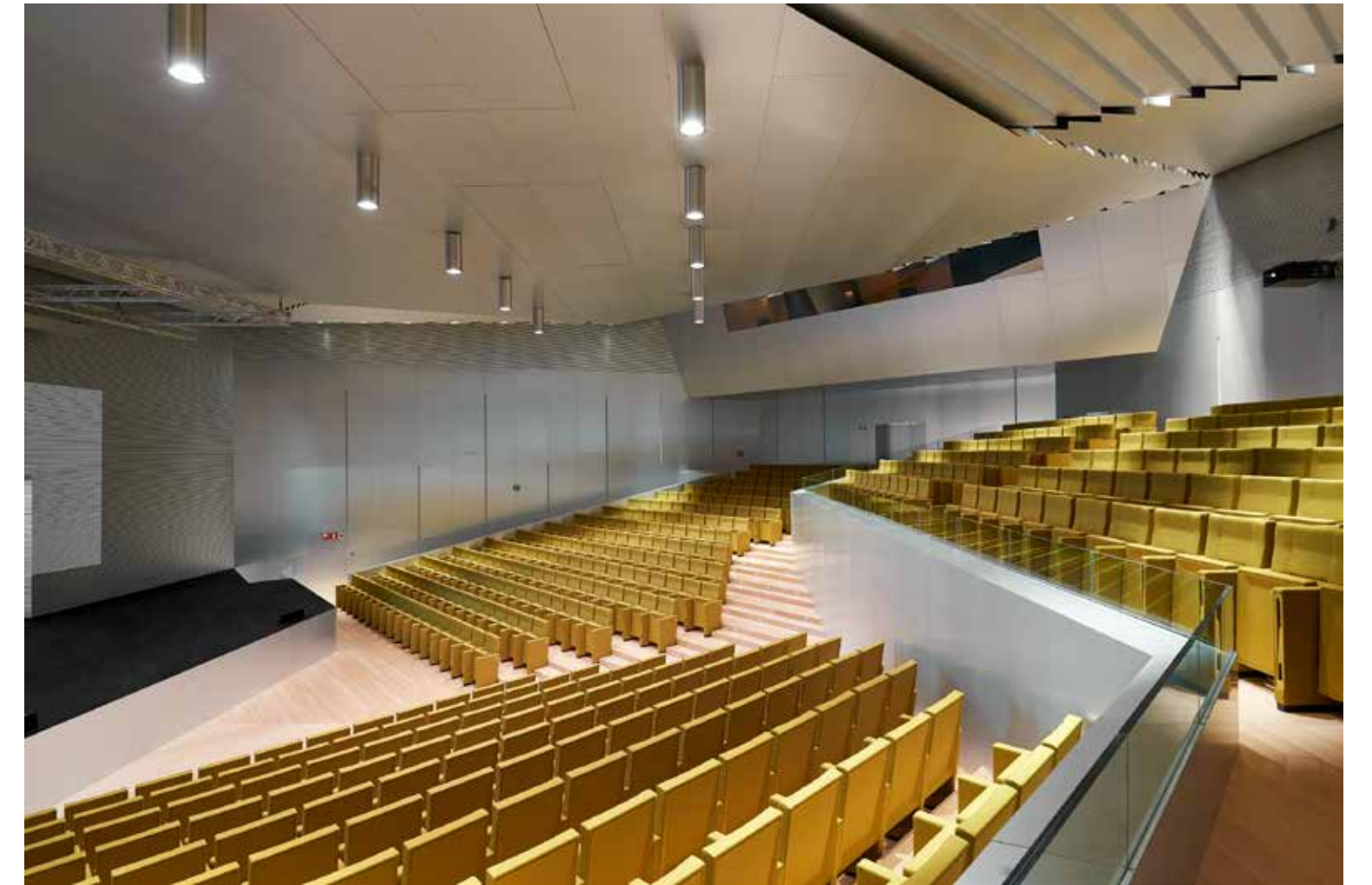

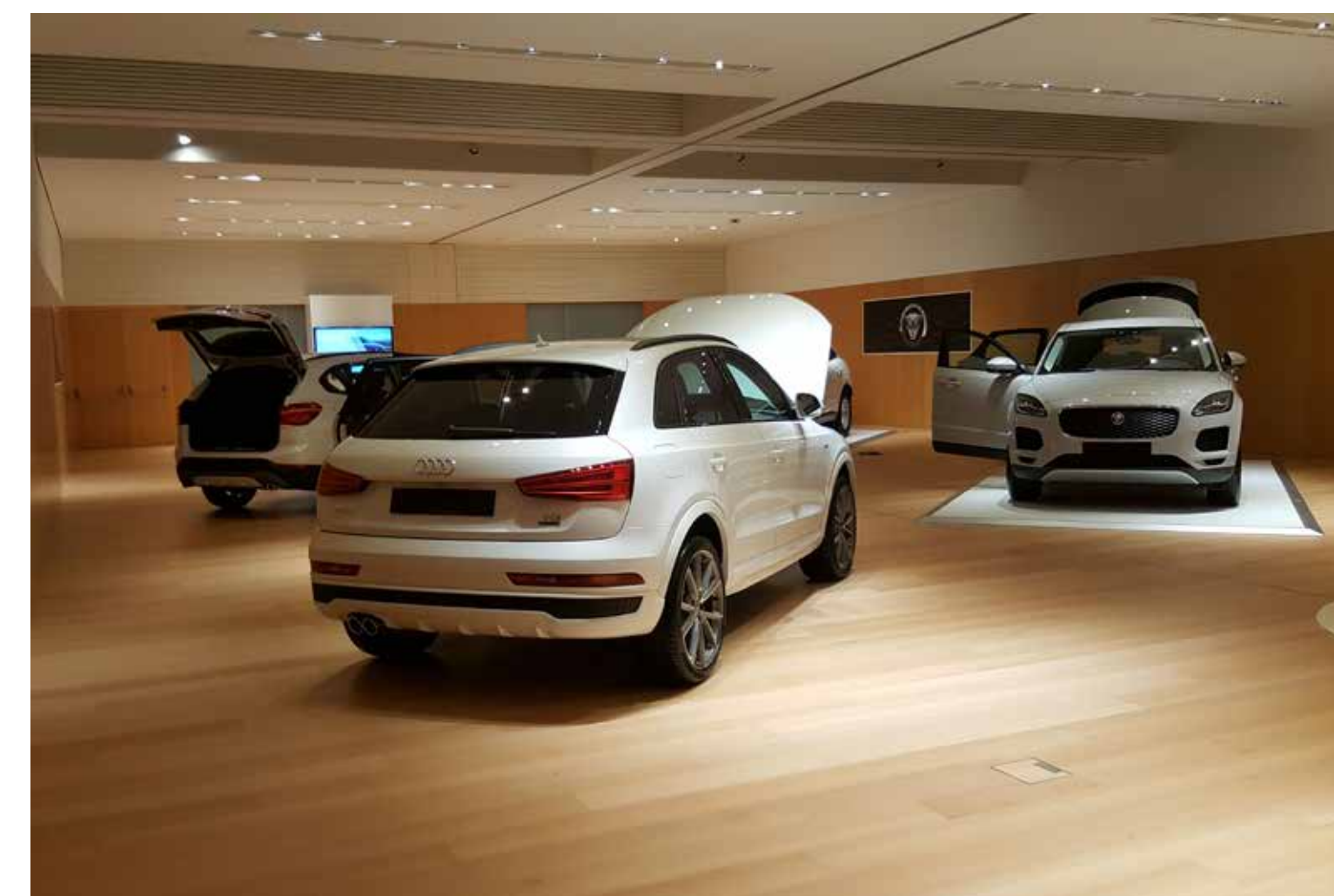

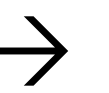

Value with flavour

The *Palau de Congressos* of Palma managed by Meliá Hotels International, relies on the experience of its own great professional team for the organization of all sorts of events, offering a broad selection of business lunches, healthy coffee breaks, gala dinners or cocktails and ensuring impeccable care on every detail.



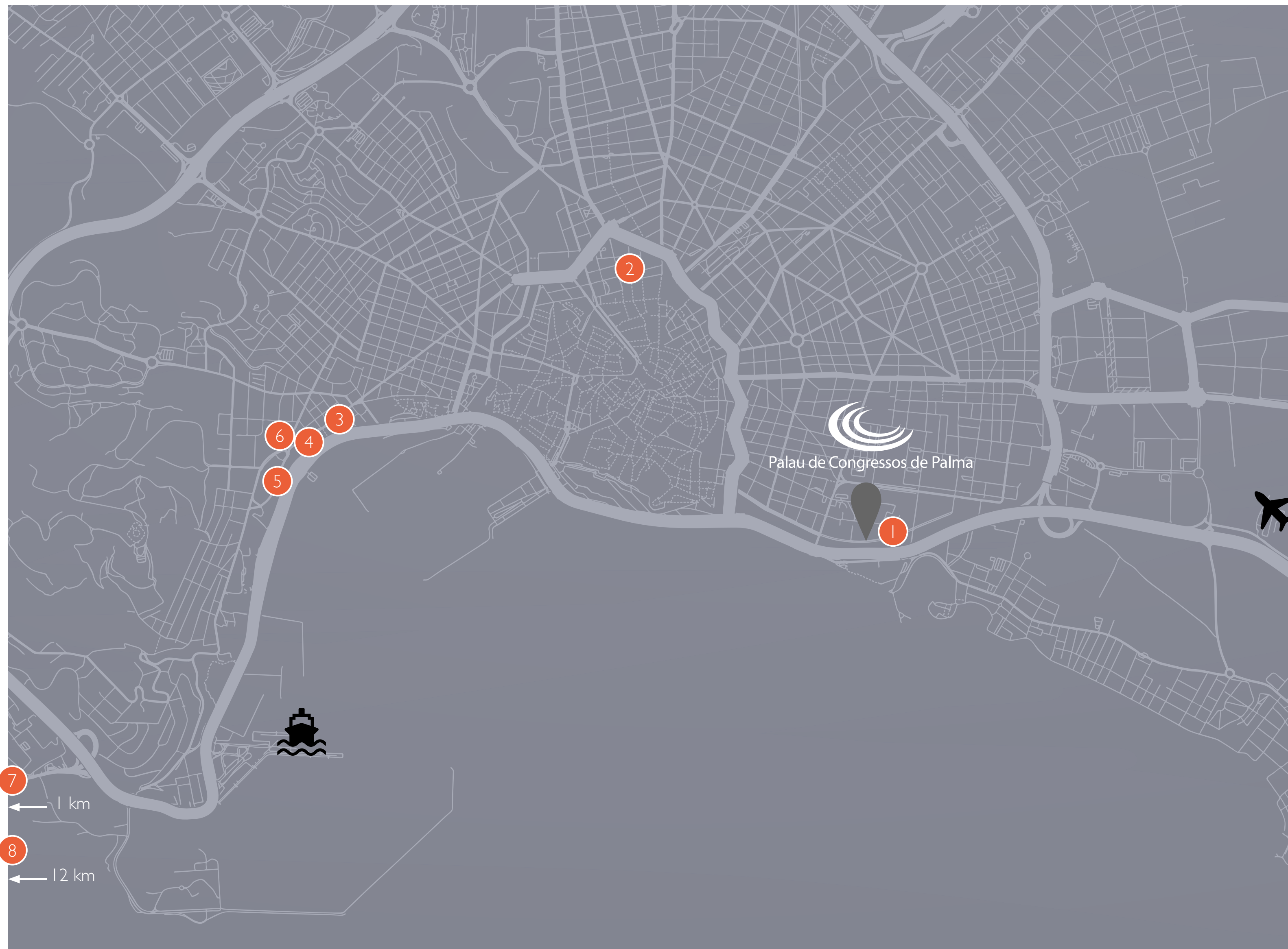

Meliá Hotels International Hoteles in Palma

- 1 MELIÁ PALMA BAY
- 2 INNSIDE PALMA CENTER
- 3 HOTEL PALMA BELLVER
- 4 MELIÁ PALMA MARINA
- 5 GRAN MELIÁ VICTORIA
- 6 INNSIDE PALMA BOSQUE
- 7 GRAN MELIÁ DE MAR
- 8 MELIÁ CALVIÁ BEACH



1 MELIÁ PALMA BAY

268 BEDROOMS
4 STARS SUP.

2 INNSIDE PALMA CENTER

101 BEDROOMS
4 STARS

3 HOTEL PALMA BELLVER

384 BEDROOMS
4 STARS

4 MELIÁ PALMA MARINA

345 BEDROOMS
4 STARS



5 GRAN MELIÁ VICTORIA

171 BEDROOMS
5 STARS

6 INNSIDE PALMA BOSQUE

262 BEDROOMS
4 STARS

7 GRAN MELIÁ DE MAR

142 BEDROOMS
5 STARS

8 MELIÁ CALVIA BEACH

300 BEDROOMS
4 STARS



Data Sheet



FLOOR 0

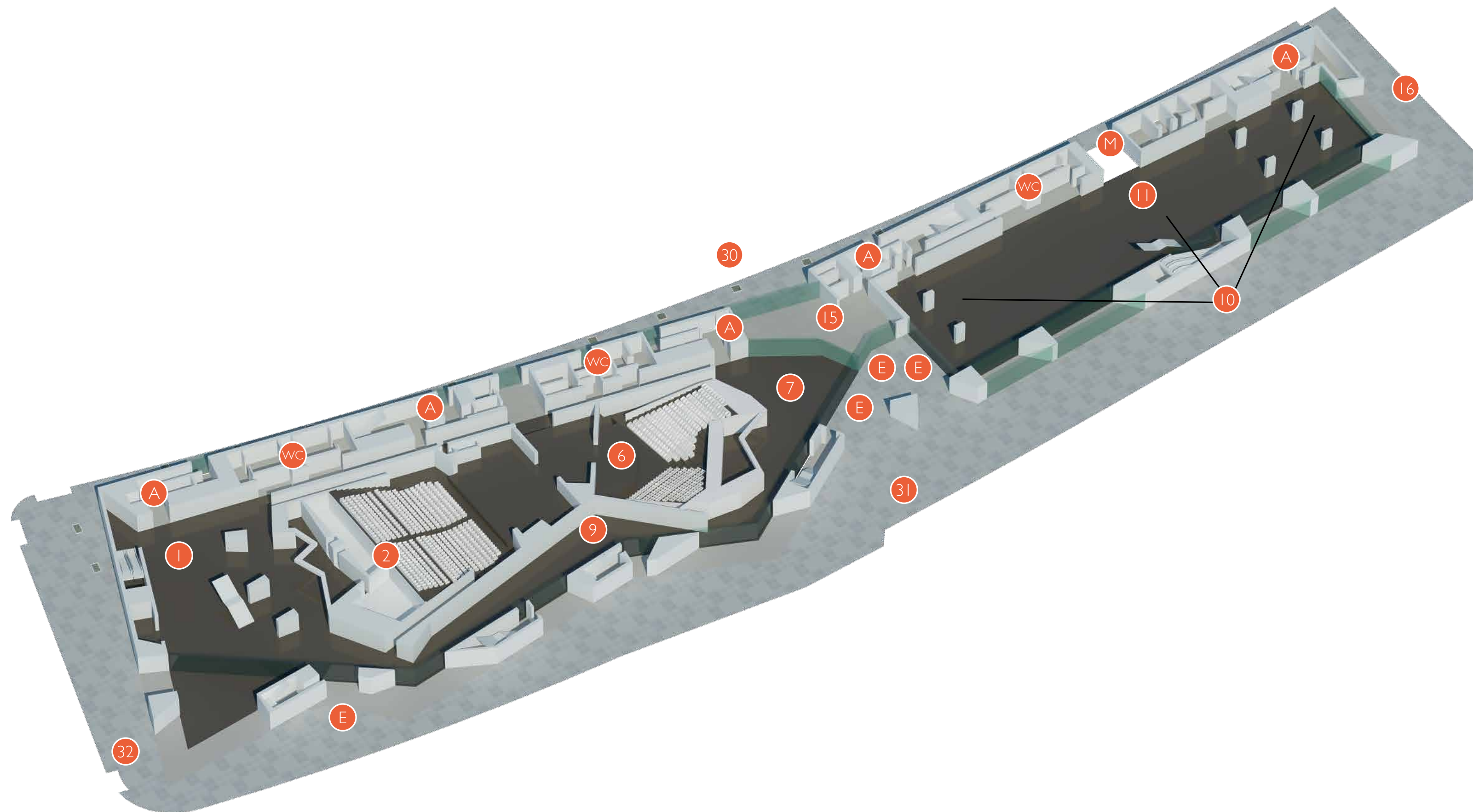

1 HALL AUDITORIUM ILLES BALEARS
- M2: 825

2 AUDITORIUM ILLES BALEARS

6 AUDITORIUM MALLORCA

7 HALL AUDITORIUM MALLORCA
- M2: 1250

9 HALL CONECTOR
- M2: 345

10 EXPO
- M2: 2340
- Height: 11/7,6

11 EXPO 1
- M2: 1620
- Height: 11

15 ELYXR CAFÉ
- M2: 230

16 THE SQUARE
- M2: 1050

M SERVICE ELEVATOR

30 FELICIA FUSTER STREET

31 PASEO MARÍTIMO

32 MANUEL AZAÑA STREET

E ENTRANCE

A ELEVATOR

WC BATHROOMS



FLOOR 1

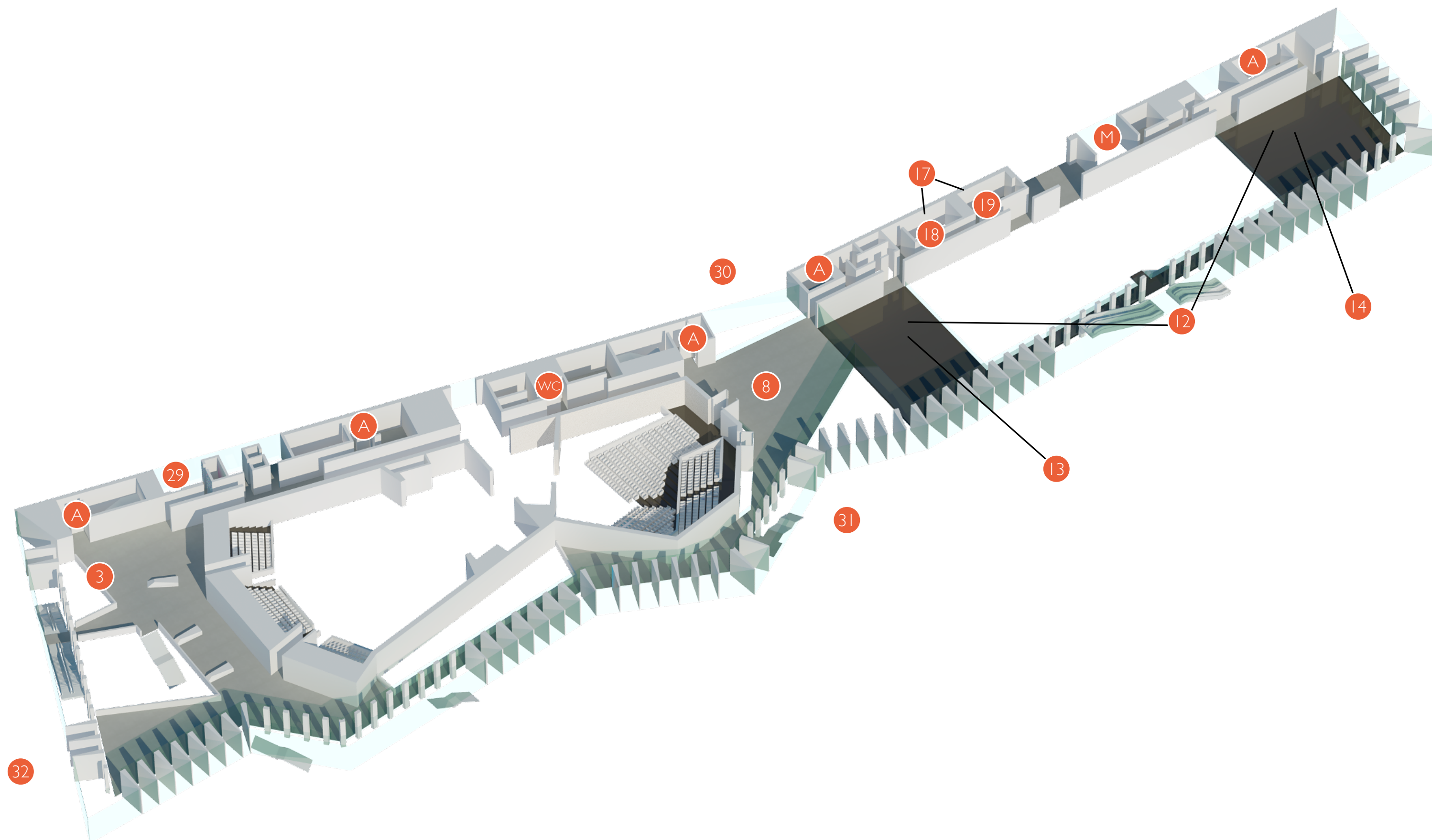

- 3 HALL 1 AUDITORIUM ILLES BALEARS
- M2: 736
- 8 HALL 1 AUDITORIUM MALLORCA
- M2: 398
- 12 EXPO 2
- M2: 700
- Height: 7,6

- 13 EXPO 2.1
- M2: 325
- Height: 7,6
- 14 EXPO 2.2
- M2:
- Height: 7,6
- 17 CALVIA
- M2: 58
- Height: 2,6

- 18 CALVIA 1
- M2: 28
- Height: 2,6
- 19 CALVIA 2
- M2: 28
- Height: 2,6
- M SERVICE ELEVATOR

- 29 DRESSING ROOM 1, 2 AND INFIRMARY
DRESSING ROOM 1
- M2: 43
- Height: 2,6
DRESSING ROOM 2
- M2: 21
- Height: 2,6
INFIRMARY
- M2: 21
- Height: 2,6

- 30 FELICIA FUSTER STREET
- 31 PASEO MARÍTIMO
- 32 MANUEL AZAÑA STREET

- A ELEVATOR
- WC BATHROOMS

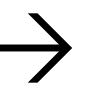

FLOOR 2

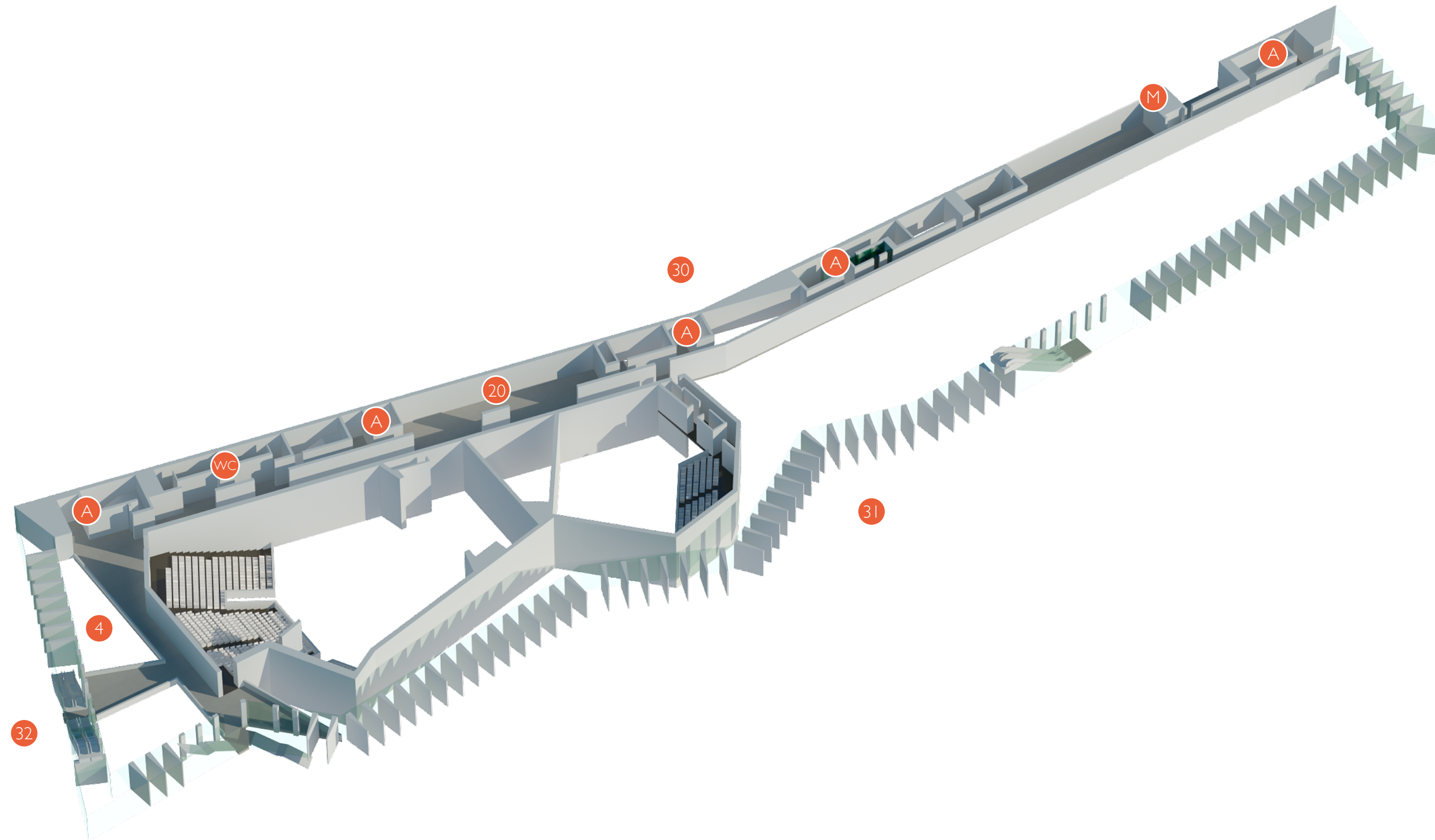

4 HALL 2 AUDITORIUM ILLES BALEARS
- M2: 274

20 CABRERA
- M2: 149

M SERVICE ELEVATOR

30 FELICIA FUSTER STREET

31 PASEO MARÍTIMO

32 MANUEL AZAÑA STREET

A ELEVATOR

WC BATHROOM



FLOOR 3

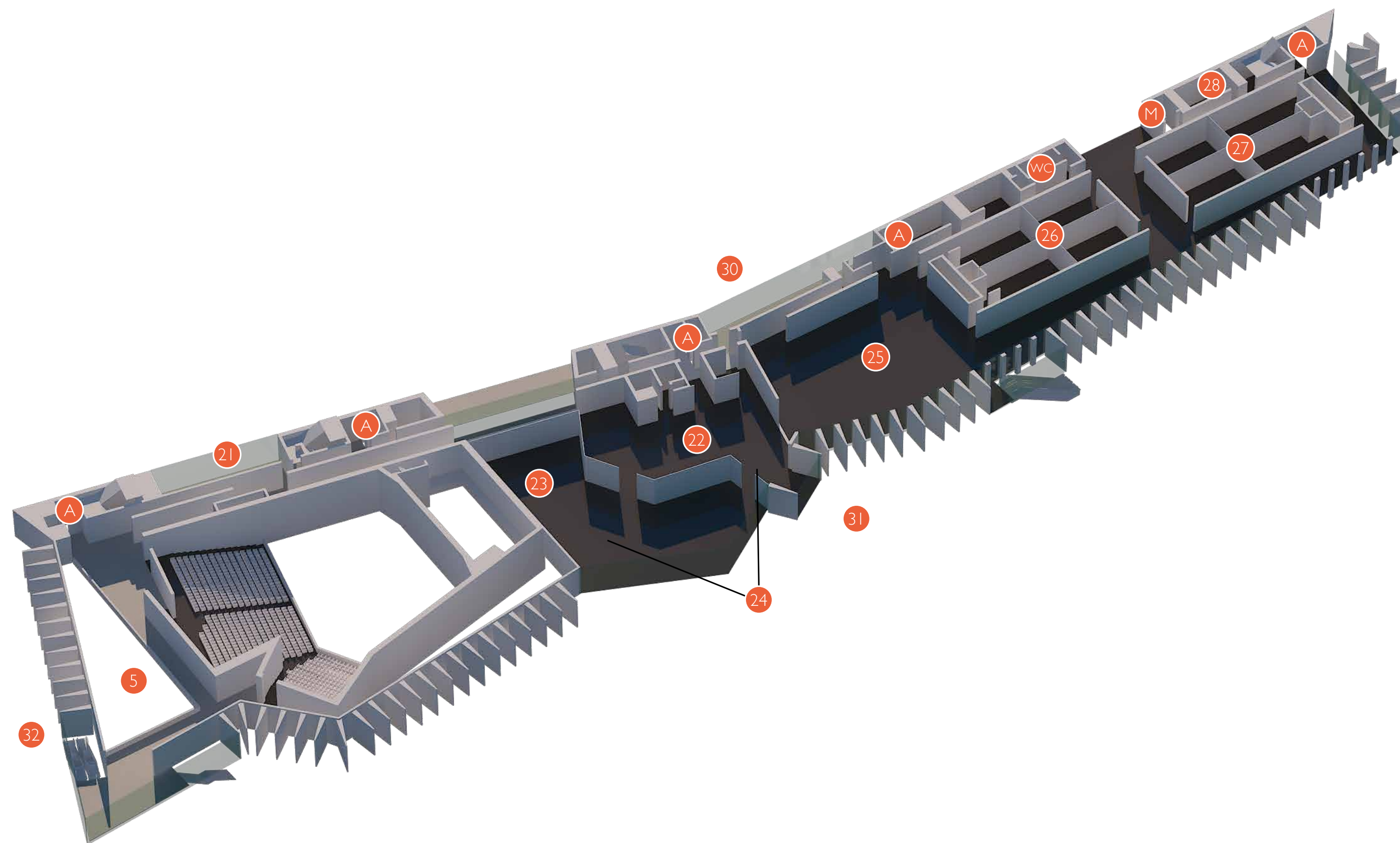

- 5 HALL 3 AUDITORIUM ILLES BALEARS
- M2: 327
- 21 INCA
- M2: 87
- Height: 2,6
- 22 PALMA
- M2: 620

- 23 ROOFTOP PALMA
- M2: 600
- Height: NA
- 24 ROOFTOP PALMA + PALMA
- M2: 1220
- Height: NA
- 25 HALL MENORCA
- M2: 1061









- 26 MENORCA
- M2: 320
- Height: 3,8
- 27 EIVISSA
- M2: 320
- Height: 3,8
- 28 FORMENTERA
- M2: 68
- Height: 2,6

- M SERVICE ELEVATOR
- 30 FELICIA FUSTER STREET
- 31 PASEO MARÍTIMO

- 32 MANUEL AZAÑA STREET
- A ELEVATOR
- WC BATHROOM



MESUREMENT & CAPACITY

	PLANTA FLOOR	M ²	ALTURA HEIGHT	 BANQUETE BANQUET	 CABARET	 COCKTAIL	 ESCUELA SCHOOL	 SILLA-PALA DESK-CHAIR	 TEATRO THEATER	 IMPERIAL	 EN "U" "U" SHAPE
AUDITORI ILLES BALEARS	0 + 1 + 2 + 3		-	-	-	-	-	-	1.966	-	-
HALL AUDITORI ILLES BALEARS	0	825	-	-	-	600	-	-	-	-	-
HALL 1 AUDITORI ILLES BALEARS	1	736	-	-	-	550	-	-	-	-	-
HALL 2 AUDITORI ILLES BALEARS	2	274	-	-	-	150	-	-	-	-	-
HALL 3 AUDITORI ILLES BALEARS	3	327	-	-	-	250	-	-	-	-	-
AUDITORI MALLORCA	0 + 1		-	-	-	-	-	-	471	-	-
HALL AUDITORI MALLORCA	0	1.250	-	-	-	200	-	-	-	-	-
HALL 1 AUDITORI MALLORCA	1	398	-	-	-	300	-	-	-	-	-
CAMERINO 1	1	43	2,6	-	-	-	-	10	15	10	-
CAMERINO 2	1	21	2,6	-	-	-	-	8	10	8	-
ENFERMERÍA	1	21	2,6	-	-	-	-	-	-	-	-
EXPO	0 + 1	2.340	11 / 7,6	1.810	1.159	2.295	-	-	-	-	-
EXPO 1	0	1.640	11	850	680	1.900	1.000	-	916	-	-
EXPO 2	1	700	7,6	460	368	550	-	-	-	-	-
EXPO 2.1	1	325	7,6	210	168	250	144	288	320	72	-
EXPO 2.2	1	375	7,6	250	200	300	168	340	288	80	-



MESUREMENTS & CAPACITY

	PLANTA FLOOR	M ²	ALTURA HEIGHT	BANQUETE BANQUET	CABARET	COCKTAIL	ESCUELA SCHOOL	SILLA-PALA DESK-CHAIR	TEATRO THEATER	IMPERIAL	EN "U" "U" SHAPE
CALVIÁ (1 + 2)	1	58	2,6	-	-	-	24	40	50	20	20
CALVIÁ 1	1	28	2,6	-	-	-	25	25	25	12	12
CALVIÁ 2	1	28	2,6	-	-	-	12	25	25	12	12
CABRERA (1 + 2 + 3 + 4 + 5)	2	149	2,6	-	-	-	64	91	176	68	68
CABRERA 1	2	25	2,6	-	-	-	8	20	23	8	8
CABRERA 2	2	31	2,6	-	-	-	12	25	30	12	12
CABRERA 3	2	31	2,6	-	-	-	12	25	30	12	12
CABRERA 4	2	31	2,6	-	-	-	12	25	30	12	12
CABRERA 5	2	31	2,6	-	-	-	12	25	30	12	12
CABRERA (1+2) (2+3) (3+4) (4+5)	2	62	2,6	-	-	-	20	36	59	24	24
CABRERA (1+2+3)(2+3+4)(3+4+5)	2	93	2,6	-	-	-	36	58	90	36	36
CABRERA (1+2+3+4) (2+3+4+5)	2	124	2,6	-	-	-	48	71	141	52	52
INCA	3	87	2,6	-	-	-	36	48	48	24	26
PALMA	3	620	3,78	300	210	400	-	-	-	-	-
ROOFTOP PALMA	3	600	-	250	-	400	-	-	-	-	-
ROOFTOP PALMA + PALMA	3	1.220	-	550	-	800	-	-	-	-	-
HALL MENORCA	3	1.061	3,6	460	-	800	272	484	552	-	-

	PLANTA FLOOR	M ²	ALTURA HEIGHT	BANQUETE BANQUET	CABARET	COCKTAIL	ESCUELA SCHOOL	SILLA-PALA DESK-CHAIR	TEATRO THEATER	IMPERIAL	EN "U" "U" SHAPE
MENORCA (1 + 2 + 3 + 4)	3	320	3,8	240	192	280	144	360	360	52	52
MENORCA 1	3	80	3,8	60	48	-	36	64	64	24	26
MENORCA 2	3	80	3,8	60	48	-	36	64	64	24	26
MENORCA 3	3	80	3,8	60	48	-	36	64	64	24	26
MENORCA 4	3	80	3,8	60	48	-	36	64	64	24	26
MENORCA (1+2) (3+4)	3	160	3,8	120	96	-	78	168	168	52	50
MENORCA (1+4) (2+3)	3	160	3,8	120	96	-	78	168	168	52	50
EIVISSA (1 + 2 + 3 + 4)	3	320	3,8	240	192	280	144	360	360	52	52
EIVISSA 1	3	80	3,8	60	48	-	36	64	64	26	26
EIVISSA 2	3	80	3,8	60	48	-	36	64	64	26	26
EIVISSA 3	3	80	3,8	60	48	-	36	64	64	26	26
EIVISSA 4	3	80	3,8	60	48	-	36	64	64	26	26
EIVISSA (1+2) (3+4)	3	160	3,8	120	96	-	78	168	168	52	50
EIVISSA (1+4) (2+3)	3	160	3,8	120	96	-	78	168	168	52	50
FORMENTERA (1 + 2 + 3)	3	68	2,6	-	30	-	28	66	66	25	30
FORMENTERA 1	3	22	2,6	-	8	-	8	20	23	8	8
FORMENTERA 2	3	22	2,6	-	8	-	8	20	23	8	8
FORMENTERA 3	3	22	2,6	-	8	-	8	20	23	8	8
FORMENTERA (1+2) (2+3)	3	44	2,6	-	16	-	20	42	42	16	20



Basic audiovisual equipment in *Illes Balears* Auditorium



SOUND EQUIPMENT:

Sound table Yamaha QL5 with 32 DANTE channels



TELEX Intercom system consisting of multiple plug-in points distributed in the auditorium. 12 headphones RTS BP 1002. Wireless Intercom system RTS with two beltpacks compatible with the TELEX system.



Wireless hand microphone Shure SLX SM 58 (2 units)



Electroacoustic system type Line Array DAS Aero12A + 4 Subs DAS VANTEC 15 + Front flr DAS ARTEC 506



Microphone headset Shure UR4 (2 units)



Simultaneous translation analogical system from Bosch Integrus



LIGHTING:

4 Profile Spotlights Robert Juliat SX714 2Kw



Robotic lighting
(Previous request & extra budget)
16 units Vari Lite VL3000



4 Fresnell Spotlights 1KW RAMA
2 Fresnell Spotlights 2KW RAMA



16 units Vari lite VL2000



12 Spotlights PAR ALTMAN S4 575w



12 units Martin Mac 2000



12 units Clay Paky Alpha Wash



Digital light monitoring table
Strand Palette VL



16 units PAR PRO (LED)



VIDEO:

Projection system
Video projector BARCO RLS W12
Projector DLP de 1 chip. Resolution
1920X1200. Brightness: 12.000
lumens. Optical zoom. Signal
distribution system HDMI / HD-SDI



Unwinding Screen frontal projection
8,50x4,,80m



CCTV System (Recording equipment
not included). 2 robotic cameras Sony
SRG-300SE & control SONY RM-IP10



Palau de Congressos de Palma

Managed by Meliá Hotels International